



4P14

SITE SPECIFICATIONS

- **BAY HEIGHT:** 78" rise plus vehicle
- **BAY WIDTH:** 12' recommended
- **BAY DEPTH:** 24' recommended
- **POWER REQ.:** 208-230v Single Phase*, 30-amp breaker
- **MIN. CONCRETE SPEC:** 4" thick, reinforced, free from cracks/seams, rated at 3500+ psi, cured at least 28 days
- **AIR REQUIRED:** 90-120 psi

SERVICE BAY LAYOUT

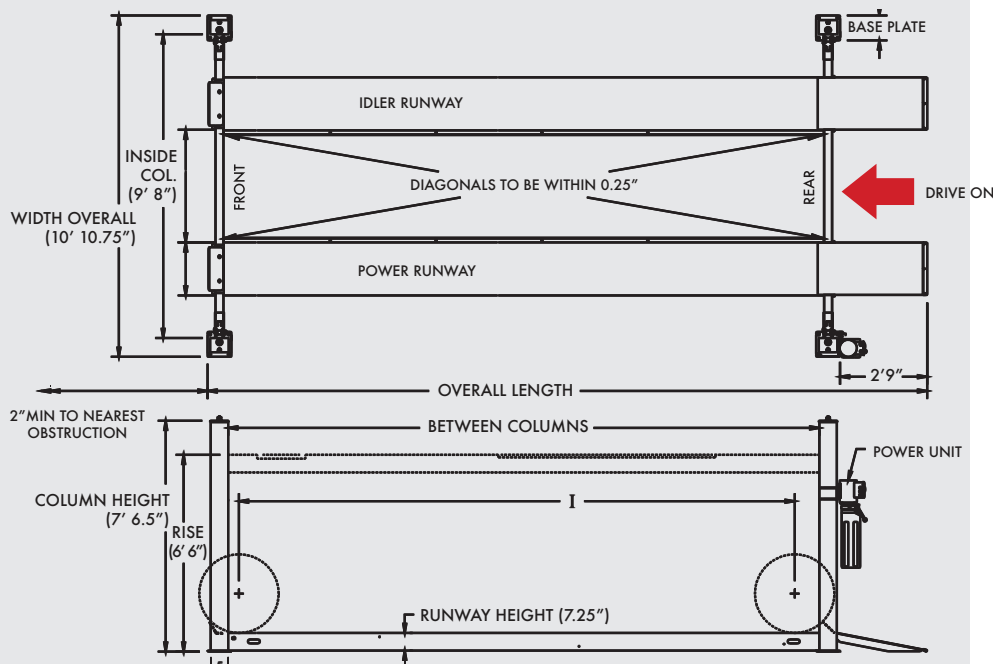

Model Number	4P14EFX	4P14XFX
Lifting Capacity	14,000 lbs.	
Open or Closed Front	Closed	
Max. Wheelbase	182.5"	210"
Rise Height	78"	
Overall Length	245.75"	273.25"
Overall Width	130.75"	
Inside Columns	116"	
Between Columns	196"	223.5"
Height of Columns	90.5"	
Width of Runways	20"	
Height of Runways	7.25"	
Width Between Runways	40" / 43"	
Air Supply Required	90-120 psi	
Motor / Voltage	2HP, 208v-230v, 60Hz, 1Ph	
Speed or Rise	90 s	
Min. Recomm. Bay Size	12' x 24'	12' x 26'
ALI/ETL Certified	√	√
Colors Available		

*3-phase upgrade is available for purchase

www.challengerlifts.com
1-800-648-5438